

92 IG series

x92x25mm



General Specifications

- Motor : Shaded pole AC motor
- Frame & Impeller : Al Die-casting & PBT plastic
- Storage temperature : -40°C to +75°C
- Operating temperature : -10°C to +70°C

Major Characteristic Parameters

Model	Bearing System	Rated Voltage	Freq.	Power Input	Rated Speed	Maximum Air Flow		Maximum Static Pressure		Sound Level	Weight
Part NO.	B / S	V	Hz	W	RPM	m ³ /min	CFM	mm-H ₂ O	In-H ₂ O	dBA	Kg
IGE09225_1H	B / S	110	50/60	15/13	2400/2800	0.85/0.99	30/35	4.0/5.0	0.16/0.20	30/31	0.29
IGE09225_2H	B / S	230	50/60	15/13	2400/2800	0.85/0.99	30/35	4.0/5.0	0.16/0.20	30/31	0.29

*Bearing system B: Two Ball Bearing F: Fluid Bearing S: Sleeve Bearing

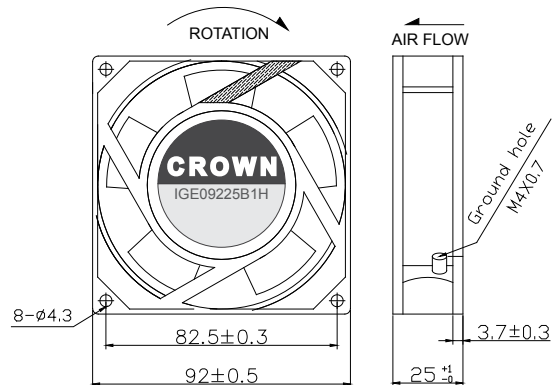
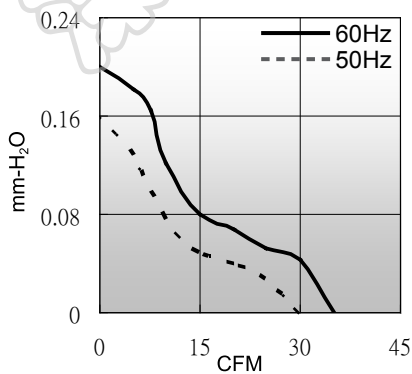

unit:mm